



INSTALLATION AND MAINTENANCE MANUAL FOR
EXPLOSIONPROOF LIGHT FITTING

Protec EX



Carefully read the instructions before
mounting the light fitting.

TABLE OF CONTENTS:

1.	GENERAL INFORMATION – PROPER USE	3
2.	TECHNICAL INFORMATION	5
3.	PHOTOMETRICAL DATA.....	5
4.	CONSTRUCTION DESCRIPTION	6
5.	PRELIMINARIES.....	6
6.	LIGHT FITTING MOUNTING	7
7.	ELECTRICAL CONNECTION	7
8.	CONDITIONS OF SAFETY USE.....	8
9.	LIGHT FITTING MAINTENANCE AND SERVICING.....	8
10.	CLEANING	9
11.	REPAIRING & EXCHANGE	9
12.	LIGHT SOURCE EXCHANGE	9
13.	TRANSPORT AND CONDITIONS OF STORAGE.....	10
14.	DISPOSAL OF WASTE EQUIPMENT.....	10
15.	WARRANTY	10

1. GENERAL INFORMATION – PROPER USE

Protec EX light fittings are designed to light indoor and outdoor areas in zone 2 of explosion hazard of gas, vapors, or clouds of flammable liquids mixed with air which belongs to IIA, IIB or IIC explosion group, T1-T4 temperature class. Protec EX light fittings are also suitable to light areas in zone 22 of explosion hazard of dust and flammable fibers mixed with air which self-ignition temperature is higher than 105°C, and the temperature of glowing layers of dust (5mm) is higher than 145°C.

DOSTĘPNE KONFIGURACJE | AVAILABLE OPTIONS

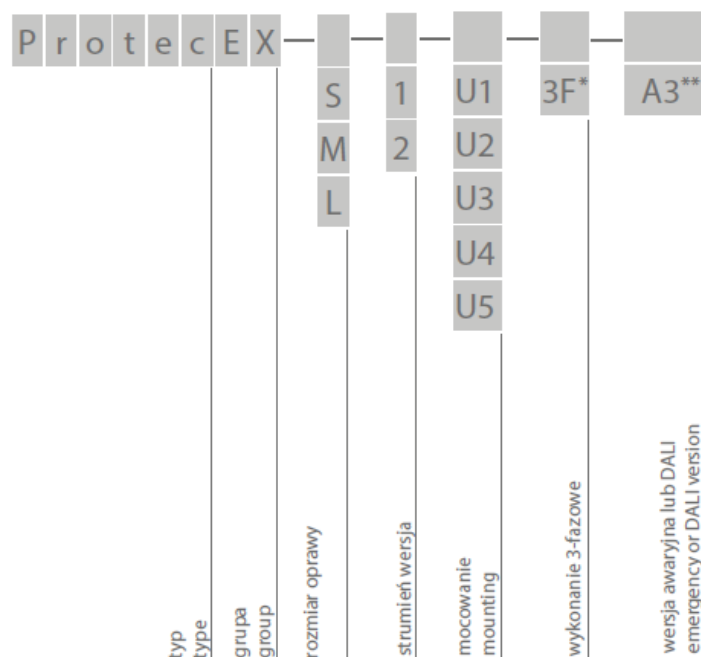

TECHNICAL INFORMATION

Ex marking:

- For Protec EX - * - * - **



II 3G Ex ec op is IIC T4 Gc
II 3D Ex tc IIIC T70°C IP66/67 Dc

Interpretation of the use restrictions of the device by means of the symbols in the above marking and on the label of the device:

Name	Symbol	Description
Special explosionproof protection marking		Symbol of device intended for use in potentially explosive atmospheres.

Device group	II	Device intended for use in explosive atmospheres other than underground mine.
Device category	3G	Device can safely operate in zone 2 of the explosion hazard of gases, vapors and mists of flammable liquids with air.
	3D	Device can safely operate in zone 22 dust explosion hazard.
Type of execution	Ex ec	Device secured with increased safety construction type "e".
	Ex tc	Device secured from dust ignition with the housing type „t”.
Group	IIC	Device can be used in the presence of explosion hazard gases, vapors and mists of flammable liquids with air classified as explosive groups IIA, IIB, IIC.
	IIIC	Device can be used in the presence of explosion hazard of combustible dusts and filaments belonging to explosion groups IIIA, IIIB, IIIC (all types of dusts).
Temperature class	T4	Device intended for use in potentially explosive atmospheres of gases with self-ignition temperature > 135°C
Temperature	T70°C	Device can be used in presence of dusts whose cloud self-ignition temperature is higher than 105°C, and the glowing temperature of the layer (5mm) is higher than 145°C.
Explosion protection level	Gc	Device intended for installation in zone 2 of gas explosion hazard, providing a „normal safety” and which will not become a source of ignition under normal conditions of use and during expected damage.
	Dc	Device intended for installation in zones 22 dust explosion hazard, providing a „normal level of safety” and which will not become a source of ignition under normal conditions of use and during expected damage.

Explosive group:	IIA, IIB, IIC
Protection degree:	IP66/IP67
Cross section admission cable:	1-2.5mm ²
Admission cable diameter::	Ø 8-13mm
Voltage:	230V, 0/50-60Hz
Protection class:	I
Ambient temperature Ta:	-25°C ... +45°C for all versions

LED module risk group RG=1

2. TECHNICAL INFORMATION

Type	Power	Electrical unit	IP	Protection class	Power factor	Ambient temp.
Protec EX-S-1	18,2 W	230V 0,50,60Hz	66/67	I	≥0,97	-25 do +45°C
Protec EX-S-2	26,1 W					
Protec EX-M-1	35,4 W					
Protec EX-M-2	51,3 W					
Protec EX-L-1	44,0 W					
Protec EX-L-2	59,8 W					

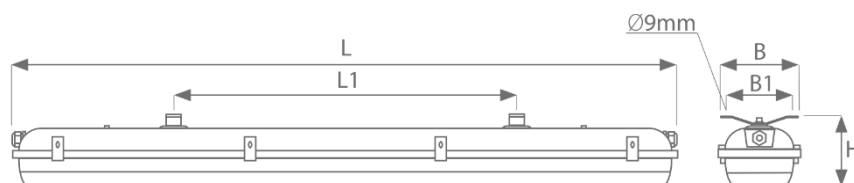

Type	L	L1	B	B1	H
Protec EX-S	673	450	190	160	134
Protec EX-M	1283	660			
Protec EX-L	1583	900			

3. PHOTOMETRICAL DATA

Type	Luminous flux	Efficiency	Colour temperature	CRI	Lifetime
Protec EX-S-1	2470 lm	136 lm/W	4000K/6500K	>80	>72000 h
Protec EX-S-2	3441 lm	132 lm/W			
Protec EX-M-1	4940 lm	140 lm/W			
Protec EX-M-2	6882 lm	134 lm/W			
Protec EX-L-1	6176 lm	140 lm/W			
Protec EX-L-2	8603 lm	135 lm/W			

Lifetime of a LED modules: L₈₀F₁₀

4. CONSTRUCTION DESCRIPTION

Light fittings are built according to PN-EN 60598-1: 2015-04, PN-EN 60079-0: 2018-09, PN-EN 60079-7: 2016-02, PN-EN 60079-31: 2014-10 and general principles of good engineering practice. The product meets the essential requirements of the Directives and the harmonized standards listed in the EU Declaration of Conformity. Used solutions and materials, electrical equipment and proper insulating spaces makes that during normal exploitation there is no possibility any sparks, electrostatic charge, dangerous heating or light fitting destruction caused by environment factors occurrence.

Light fittings are built as a one chamber equipment. Mounting tray and brackets are made of powder painted galvanized steel. Closing clamps are made of stainless steel.

Used terminals ensures safe and non-sparking connection of inner wires and admission cables. The diffuser is made of polycarbonate (PC) type "Makrolon 2207" resistant to UV radiation.

5. PRELIMINARIES

SAFETY RULES

- Carefully read all the information included in the manual before mounting the light fitting.
- General safety rules must be followed.
- Failure to comply with rules of the installation and use can lead to personal injury or property loses. ATM Lighting sp. z o.o. company takes no responsibility in such cases.
- Failure to comply with rules included in manual results with void of the manufacturer warranty.
- Manufacturer takes no responsibility for any damages resulting from improper installation, maintenance or improper use.
- It is the responsibility of the user to perform the installation in accordance with this manual and the safety regulations and standards applicable to the type of installation
- In case of malfunction, the device must be turned off and returned for repair to the manufacturer or his authorized entity.



Before performing any installation work, including opening the enclosure, be absolutely sure to disconnect the unit from the power source.

NECESSARY TOOLS

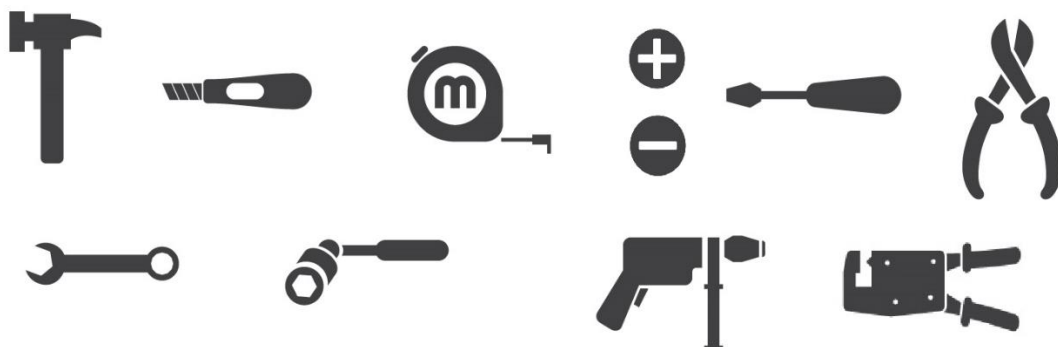

6. LIGHT FITTING MOUNTING

Light fitting is mounted with use of two brackets, designed for direct installation on a ceiling or on a wall. Spacing and size of the mounting holes are shown in point 2.

7. ELECTRICAL CONNECTION



Installation and electrical connection should be in accordance with the requirements of PN-EN 60079-14:2014-06.

To connect power supply:

- enter the power cable to the housing through the cable entry (gland),
- carefully unisolate the wires (8-10mm), and put it into the connector according to a label inside the light fitting,
- precisely tighten power cable in the gland with two wrench,
- check the effectiveness of grounding.

Power connection:

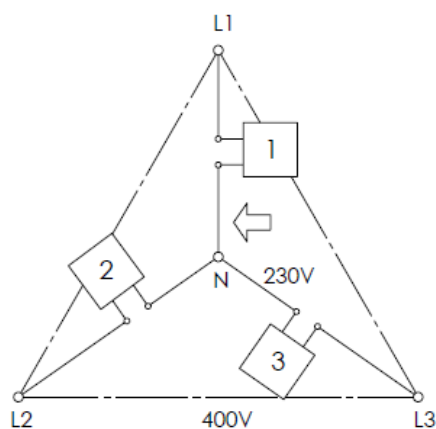
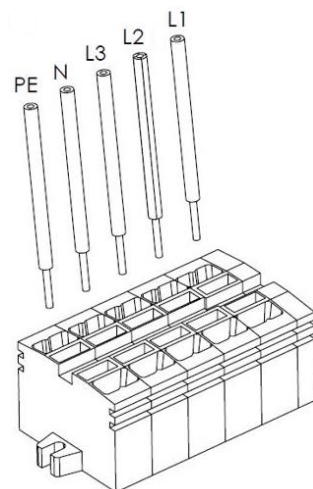

Correct connection

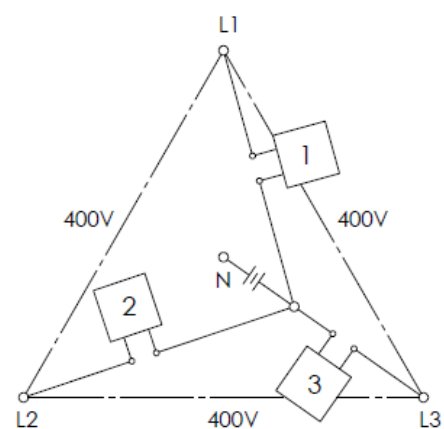

Faulty connection



Remarks:

- Use one wrench to tighten the sealing nut, while using the second wrench to block gland body against rotation, otherwise damage of the sealing can be caused and therefore sealing level will be decreased and thus explosion protection.
- Damage of a Neutral line or a current occurring in it may expose a luminaire or group of luminaires to a current exceeding acceptable values which may cause an irreversible damage to power supply system.

8. CONDITIONS OF SAFETY USE

- Every light fitting must have label with rating data on it. Each light fitting is equipped with this „Installation and maintenance manual”, which must be kept by user until the end of exploitation.
- Light fittings are designed for fixed installations only.
- Using light fitting outside the designated operating temperature range is unacceptable and will decrease a lifetime of light fitting and/or damage it. It will also cause a loss of warranty.



Remark: Using light fitting beyond the designated operating temperature range may result in the loss of explosion protection measures, such as exceed temperature class and explosion.

- Each light fitting must have a warning sign: „DO NOT OPEN UNDER VOLTAGE” on it.
- Admission cables must have 3-wires (with PE wire) and diameter 8-13mm (for M20 cable gland) or diameter 10-17 (for M25 cable gland).
- Use power wires with cross section 1-2,5mm².
- Maximum cross current I=10A.
- The diffuser and housing are made of polycarbonate, so they mustn't be exposed on chemical substances which may destroy it, especially: oil, acetone, chloride, ethyl, ether. In case of doubts with substances present in work environment of light fitting, prior investigation must be made.



- Do not stare into working light source.



- Risk of electrical shock.

9. LIGHT FITTING MAINTENANCE AND SERVICING

REMARK: during the servicing and maintenance touching the LED are prohibited, because it will decrease the lifetime of light fitting and cause the loss of manufacturer's warranty.



It is recommended to carry out inspections of electrical equipment in accordance with the requirements of PN-EN 60079-17:2014-05.

INSPECTION: at least once a month. Inspection is made without opening the light fitting. User must check admission cables condition (insulation damage, cracks, burns etc.). Cables must not have any acute bends. Outside parts of the light fitting must be checked. No cracks or corrosion signs may occur. Bolts used to mount light fitting should be properly tightened, washers mustn't be cracked. Cleanliness

of outer surfaces and light fittings surroundings must be checked. Light fittings may not be soiled by paint or grease. Do not allow for dust (dirt) deposition on the light fitting. The readability of rating and warning plates must be checked. Abnormalities found must be fixed.

REMARK: due to the danger of explosion due to electrostatic charges, the luminaire should be properly maintained by regularly cleaning it with a damp cloth with the addition of antistatic fluid.

SERVICE AND MAINTENANCE: at least once a year. Service and maintenance must be made with power supply turned off. User must make inspection steps first. After opening: metal parts painting, condition of inner wiring and its mounting, insulating materials, cable glands gaskets, terminals. Abnormalities found must be fixed. Rating and warning plates must be cleaned. Surfaces of insulating materials and covers must be clean.

VERIFICATION OF TECHNICAL CONDITION: at least once for 2 years. Power supply must be switched off. Verification of technical condition must be proceeded outside of Ex zone or with monitoring the hazard level. Work can be done if:

- Explosive atmosphere concentration does not exceed 10% of lower explosion limit (LEL) for explosive atmospheres in zone 2,
- Cleaning activities have been carried out to ensure the cleanliness of the installation (house-keeping) and dust cloud occurrence possibility is excluded in zones 22 explosion hazard.

Besides all the examination during inspection, service and maintenance paragraphs electrical examination must be also made: light fitting current consumption, insulation examination, protective earthing condition. Special attention must be paid to insulating parts condition. No crack or burns may occur.

10. CLEANING



Do not allow dust to accumulate on the light fitting. Cleaning have to be carried out using vacuum cleaners or a soft cloth with antistatic agent suitable to working conditions. If necessary, use water and / or a neutral detergent, but do not use chemicals that could damage any part of the housing.

11. REPAIRING & EXCHANGE

All spare parts must be ordered directly from the luminaire manufacturer.



All repairs may be made only by manufacturer or authorized repair workshops according to PN-EN 60079-19:2011.

12. LIGHT SOURCE EXCHANGE

Lamps exchange may be made only by specially trained personnel using the original components provided by ATM Lighting sp. z o.o.

13. TRANSPORT AND CONDITIONS OF STORAGE

During transport light fittings shouldn't be exposed to precipitation or mechanical shock.

Light fittings may be storage only in sheltered warehouses, within +5°C to +35°C temperature range, and relative humidity lower than 75%. No corrosion causing vapors or gases should be present.

14. DISPOSAL OF WASTE EQUIPMENT



User must obey relevant rules and regulations about disposal of wasted equipment valid in their country.

15. WARRANTY

- It is required to disconnect power supply from the light fitting before any maintenance work.
- It is forbidden to make any changes to the light fitting construction. Any unauthorized interference may result in reduced functionality or damage to the device and may in some cases endanger life or health. At the same time it relieves the manufacturer of all warranty liability.
- All specific information can be found in document „General terms and conditions warranty ATM Lighting sp. z o.o.” available at the website www.atmlighting.pl/en/

ADDRESS:

ATM Lighting sp. z o.o.

ul. Budowlanych 31 80-298 Gdańsk

tel: +48 58 347 51 07 fax: +48 58 347 51 08

office@atmlighting.pl